

An Investigation of Valve Lift Effect on Air Flow and Coefficient of Discharge of Four Stroke Engines Based on Experiment

Abdul Rahim Ismail, Rosli Abu Bakar, Semin
Automotive Focus Group, Faculty of Mechanical Engineering,
University Malaysia Pahang, Locked Bag 12, 25000 Kuantan, Pahang, Malaysia

Abstract: The coefficient of discharge (CD) is defined as the ratio of actual discharge to ideal discharge. In an engine environment, ideal discharge considers an ideal gas and the process to be free from friction, surface tension, etc. Coefficients of discharge are widely used to monitor the flow efficiency through various engine components and are quite useful in improving the performance of these components. The flow through engines it is equally important to have accurate values for coefficients of discharge through the combinations of valves, ports and ducts. In this experiment investigation of air flow and coefficient of discharge are desirable for inflow (reverse flow) through the exhaust port using SuperFlow Flowbench. The coefficients of discharge the diesel engines can be quite measured under steady flow conditions for a range of pressures and flows. This paper presents experimental results for air flow and coefficient of discharge investigating the intake and exhaust flow of four stroke direct injection diesel engines. The CD measurements are shown for various pressures, valve lift per diameters (L/D) ratio conditions at the intake port pipe to cylinder and cylinder to exhaust port pipe geometries.

Keywords: Coefficient of discharge, correction test flow, test pressure, valve lift, diesel engines

INTRODUCTION

The importance of the diesel engine performance parameters are geometrical properties, the term of efficiency and other related engine performance parameters. The engine efficiencies are indicated thermal efficiency, brake thermal efficiency, mechanical efficiency, volumetric efficiency and relative efficiency^[6]. A wide variety of inlet port geometries patterns used to accomplish this over the diesel size range^[1-5]. The engine ratings usually indicate the highest power at which manufacturer expect their products to give satisfactory of power, economy, reliability and durability under service conditions.

The diesel engines port flow coefficient of discharge for a particular flow discontinuity is defined as the ratio of actual discharge to ideal discharge. In an engine environment, ideal discharge considers an ideal gas and the process to be free from friction, surface tension, etc. Coefficients of discharge are widely used to monitor the flow efficiency through various engine components and are quite useful in improving the performance of these components^[7, 9-11]. This paper presents the experimental results for air flow and

coefficient of discharge the small four-stroke direct-injection diesel engines using SuperFlow Flowbench.

The SuperFlow Flowbench is designed to measure air-flow resistance of engine cylinder heads, intake manifolds, velocity stacks, and restrictor plates^[8]. In the SuperFlow Flowbench, for four-cycle engine testing, air is drawn in through the cylinder head into the machine, through the air pump and exits through the vents at each side of the flowbench. The amount of flow is displayed in cubic feet per minute (*cfm*), liters per second (*lps*) or cubic meter per hour (*cmh*). The flow meter measures the pressure difference across an adjustable flow orifice in the flowbench. By selecting different ranges, the flow meter can be used to obtain high accuracy over reads 5% to 100% of any flow range selected in either intake or exhaust flow direction. The full scale flow measurement range of SuperFlow SF-1020 can be varied from 25 cfm to 1000 cfm or 12 lps to 470 lps.

A flow test in SuperFlow Flowbench, flow testing consists of blowing or sucking air through a cylinder head or other component at a constant test pressure. Then the flow rate is measured at various valve lift. A change can be made and then the component can be re-tested. Greater air flow indicates an improvement. If the

Corresponding Author: Semin, Automotive Focus Group, Faculty of Mechanical Engineering, University Malaysia Pahang, Locked Bag 12, 25000 Kuantan, Pahang, Malaysia, Tel: +609-5492217, Fax: +609-5492244

tests are made under the same conditions, no corrections for atmospheric conditions or machine variations are required. The results of the experiment investigation may be compared directly. For more advanced tests, it is possible to adjust and correct for all variations so test results may be compared to those of any other head, tested under any conditions on any other SuperFlow flowbench. Further calculation can be made to determine valve efficiency and various recommended port lengths and cam timing. The port length and valve size illustration are shown in Fig. 1. The calculation can be cumbersome without a small electronic calculator, preferably with a square root key.

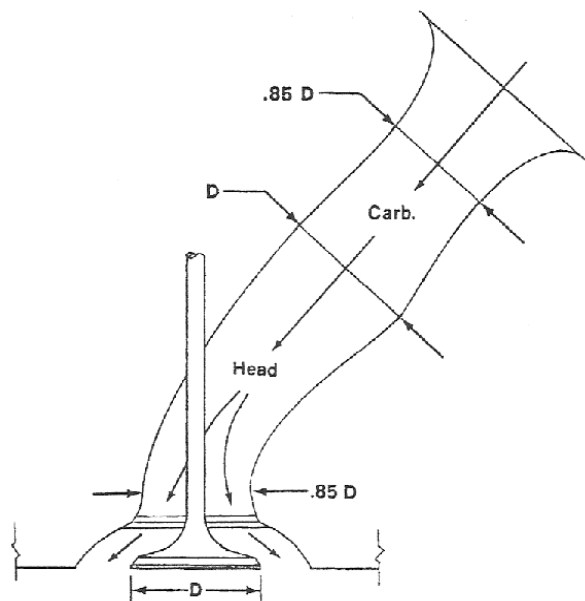

Fig. 1: Intake port area and shape^[8]

The total flow through the diesel engine is ultimately determined by the valve diameters. While well-designed smaller valves will out-perform larger valves on occasion, a good, big valve will always out-flow a good than smaller valve. Valve size is limited by the diameter of the engine bore. According to SuperFlow Technologies Group^[8], that in practice the ideal flow is never achieved but it does provide a guideline for what an efficient port would be like. If air flow losses are caused by port expansions, not contractions, it may wonder why the port should be necked down above the valve seat. The reason is the air must both turn 90 degrees and expand as it flows out the valve into the engine cylinder. Humping the port inward just above the seat allows the air to make the turn outward toward the valve edge more gradually, reducing the total flow loss. According to^[8], source of flow losses

the port are wall friction, contraction at push-rod, bend at valve guide, expansion behind valve guide, expansion in 25 degrees, expansion in 30 degrees, bend to exit valve and expansion exiting valve. The source of flow losses is shown in Fig. 2.

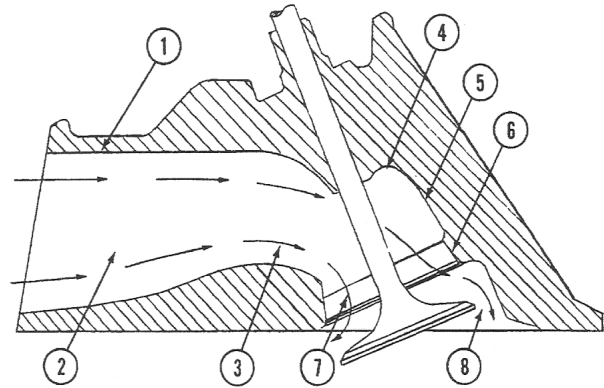

Fig. 2: Source of flow losses in the port^[8]

Source of flow loss	% of loss
1. Wall friction	4
2. Contraction at push-rod	2
3. Bend at valve guide	11
4. Expansion behind valve guide	4
5. Expansion 25 degrees	12
6. Expansion 30 degrees	19
7. Bend to exit valve	17
8. Expansion exiting valve	31
	100

MATERIALS AND METHODS

An experiment investigation to measure and analyze the air flow and coefficient of discharge of four stroke direct injection diesel engines using SuperFlow Flowbench presented in this paper. The specification of the selected diesel engine shown in Table 1. The diesel engines cylinder heads are mounted onto the SuperFlow Flowbench by a cylinder adapter. The adapter consists of a tube about 86 mm, long with the same bore as the engine in 70 mm and a flange on one end. The flange is bolted to the flow tester and the upper flange is bolted or clamped to the test cylinder head. The flanges must be flat or gasketed to make an airtight seal. The adapter tube clearance may be 0.06 inch or 1.5 mm, larger or smaller than the actual diesel engine cylinder.

A device must be attached to the diesel engine cylinder head to open the diesel engine valves to the various test positions. The usual method is to attach a threaded mount so the end of the threaded part contacts the end of the valve stem. In this experiment the

adaptor and the thread were developed from metal using CNC machine. As the thread is rotated, it pushes open the valve. In this experiment, in one rotation of the thread the valve is opened in 0.5 mm. Dial indicator may be mounted to the same fixture with its tip contacting the valve spring retainer to measure the amount of valve opening. The original valve springs used in this experiment.

Table 1: Specification of small diesel engine

Engine Parameters	Value
Bore (mm)	86.0
Stroke (mm)	70.0
Displacement (cc)	407.0
Number of cylinder	1
Maximum intake valve open (mm)	7.095
Maximum exhaust valve open (mm)	7.095
Intake valve diameter (mm)	35.54
Exhaust valve diameter (mm)	29.04
Intake valve stem (mm)	7.0
Exhaust valve stem (mm)	7.0
Intake valve effective area (sq.cm)	9.531
Exhaust valve effective area (sq.cm)	6.235

On the intake side of a four-cycle cylinder head, it is strongly recommended a radiused inlet guide be installed to lead the air straight into the head. The guide should be about one port width in thickness and be generously radiused on the inside all the way to the head of the diesel engine. The intake manifold of the diesel engine can also be used in the experiment.

All experiment test data may be recorded on the SuperFlow test data sheet forms. Before beginning the experiment test, record the test data setup. The test data setup are head description, valve stem, valve diameter, valve area, stem area and net valve area. To calculate the net valve area as below:

$$\text{Net valve area} = 0.785 \times (\text{valve diameter}^2 - \text{stem diameter}^2) \quad (1)$$

All diesel engine valves in this test should be performed at the same ratio of valve lift to valve diameter or L/D ratio. The L/D ratio calculation as below:

$$\text{L/D ratio} = \frac{\text{Valve Lift}}{\text{Valve Diameter}} \quad (2)$$

Then the flow efficiencies of any valves can be compared, regardless of size. In this research, multiply L/D ratios are 0, 0.05, 0.10, 0.15, 0.20 and 0.25. The L/D ratios are to obtain the valve lift test points.

To perform the experiment is used the test orifice plate for calibration. Remove the test orifice plate from the flowbench and install the test head, cylinder adapter and valve opener for the actual flow investigations. In this research the dial indicator was set in zero with the valve closed. Then install either the intake manifold or an air inlet guide on intake port. In this research, the test pressure was setting on 65, 55, 45, 35 and 25 of in H₂O and the test range is 4. The cylinder head leakage of the experiment setting on zero point based on first setting. The first leakage reading point is as a zero point. The valve opened in the experiment cylinder head investigation to lift on 0, 1.78, 3.55, 5.33, 7.11, and 8.89 mm for intake valve lift, and lift on 0, 1.45, 2.90, 4.36, 5.81 and 7.26 mm for exhaust valve lift.

Table 2: Valve lifts experiment position

NO	Intake Valve Lift (mm)	Exhaust Valve Lift (mm)	L/D Ratio
1	1.78	1.45	0.05
2	3.55	2.90	0.10
3	5.33	4.36	0.15
4	7.11	5.81	0.20
5	8.89	7.26	0.25

For the analysis of the experiment results data, it is necessary to measure the corrected test flow. The corrected test flow can be compared to other experiment of the same head with the same setup without further calculations. In this experiment no atmospheric corrections. To obtain the valve efficiency, it is necessary to calculate the flow in cubic feet per minute (cfm)/square inch (inch²) or liters per second (l/s)/square centimeter (cm²) of the valve area and then to compare that flow to the best yet achieved. The test flow calculation as below:

$$\text{Test Flow} = \frac{\text{Correction Test Flow}}{\text{Effective Valve Area}} \quad (3)$$

Potential flow of the engine intake and exhaust manifold investigation is using the potential flow chart in section 7^[8] of valve flow potential per unit area based on the test pressure of experiment.

$$\% \text{ Potential Flow} = \frac{\text{Test Flow}}{\text{Potential Flow}} \quad (4)$$

The % potential flow can be used as an indicator of the remaining improvement possible.

To determine the valve coefficient of discharge (CD) is divide the test flow per unit area by the

maximum potential flow per unit area for the test pressure. To calculate the valve coefficient of discharge (CD) as below:

$$CD = \frac{\text{Test Flow}}{\text{Potential Orifice Flow}} \quad (5)$$

The flow results of this experiment investigation plotted on graphs in this paper. Circles are used to indicate the intake experiment test points. Triangles are used to indicate the exhaust test points.

RESULTS AND DISCUSSION

In this experiment investigation the intake valve lift opened in 10.66 mm, more than the original intake valve lift maximum opened in 7.095mm. The maximum exhaust valve lift in this experiment is opened in 8.71 mm, more than the original exhaust valve were opened in 7.095mm. The air flow performance of the intake valve and exhaust valve of the small diesel engine in this research experiment investigation results shown in graphs in this paper.

The air flow through the engine is directly controlled by the valve lift. The farther the valve opens, the greater the flow, at least up to a point. In order to discuss a wide variety of valve sizes, it is helpful to

speak in terms of the ratio of valve lift to valve diameter, or L/D ratio. Stock engines usually have a peak lift of 0.25 of the valve diameter and for racing engines open the valves to 0.30 of the valve diameter or even 0.35 of the valve diameter[8]. In the graph in Fig. 3 shows how flow varies with lift for a well-designed valve and port. Up to 0.15 of the valve diameter, the flow is controlled mostly by the valve and seat area. At higher lifts the flow peaks over and finally is controlled by the maximum capacity of the port. Wedge-chamber intakes have lower flow at full lift due to masking and bends, and are port-limited at a 15% lower level. These valve flow potential graphs on the Fig. 3 can be used a guide for judging the performance of any valve. To determine the flow rate for a particular valve, simply multiply the flow/area from the graph by the valve minus the valve stem area. The flow rate get is not the expected flow rate, but the rather the maximum potential flow rate for a particular head at the test pressure. If the flow reaches a maximum value at a lift of about 0.30d, it may wonder why some cams are designed to open the valve farther, even as high as 0.37d. The answer is in order to open the valve more quickly and longer at lower lifts, it is necessary to overshoot the maximum head-flow point. The extra flow is gained on the flanks of the lift pattern not at the peak.

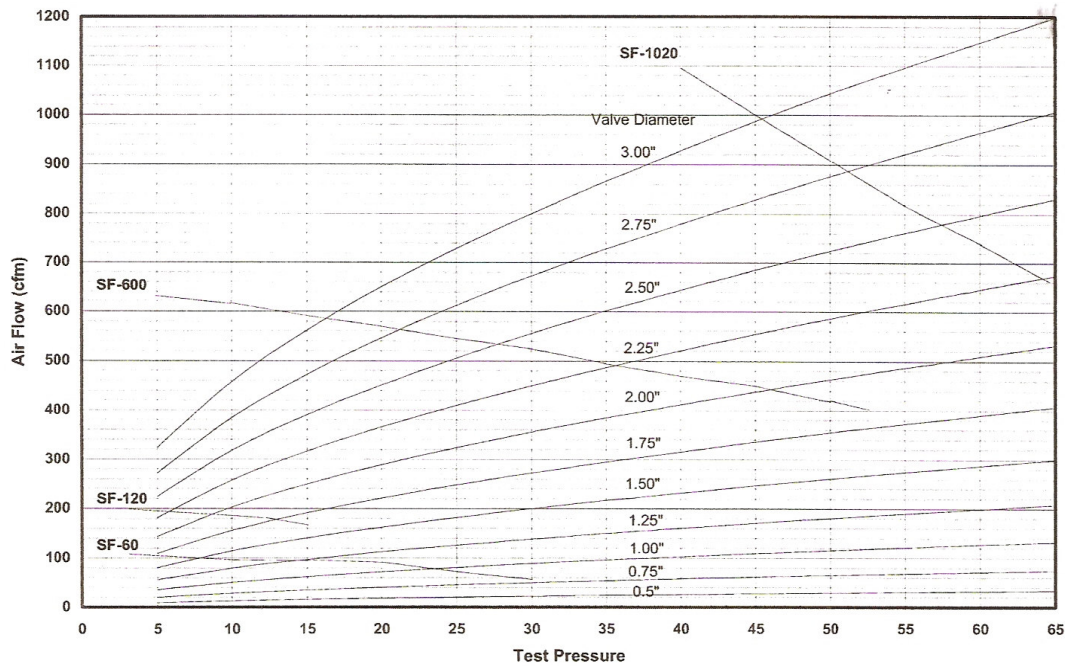

Fig. 3: Valve flow potential vs test pressure^[8]

When the induction system is installed, the total flow will drop of from 5% to 30% depending on the flow efficiency of the system. By measuring the flow at each valve lift with and without the induction system, it is possible to accurately measure the flow efficiency. Frequently, the induction system will have even more room for improvement than does the cylinder head. The experiment results to investigate the effect of valve lift for air flow and coefficient of discharge is below.

Correction test flow of the superflow flowbench is the air flow from intake manifold to engine cylinder or air flow from engine cylinder to exhaust manifold based on valve lift. The correction test flow from this experiment result is shown in Fig. 4 – Fig. 8. Fig. 4 shows the correction test flow of air flow in intake flow and exhaust flow at 165.1cm or 65in H2O test pressure, Fig. 5 shows the correction test flow of air flow in intake flow and exhaust flow at 139.7cm or 55in H2O test pressure, Fig. 6 shows the correction test flow of air flow in intake flow and exhaust flow at 114.3cm or 45in H2O test pressure, Figure 7 shows the correction test flow of air flow in intake flow and exhaust flow at 88.9cm or 35in H2O test pressure and Figure 8 shows the correction test flow of air flow in intake flow and exhaust flow at 63.5cm or 25in H2O test pressure.

In this experiment results shown that, increasing valve lift from 0L/D until 0.25L/D or 0mm until 8.89mm for intake valve lift and 0mm until 7.26 for exhaust valve lift can be increasing the correction test flow in the intake flow and exhaust flow. Fig. 4 – Fig. 8 shows that the correction test flow trend from 0L/D until 0.25L/D is increase and after 0.25L/D is stabile or horizontal. It is shown that the maximum correction test flow of the engine is near after the maximum intake valve lift or exhaust valve lift at 7.094mm. The nominal maximum flow is shown in Fig. 4 – Fig. 8, there are 57.112 liter per second for intake flow and 36.34 liter per second for exhaust flow at 165.1cm H2O test pressure, 51.45 liter per second for intake flow and 33.51 liter per second for exhaust flow at 139.7cm H2O test pressure, 45.784 liter per second for intake flow and 29.264 liter per second for exhaust flow at 114.3cm H2O test pressure, 39.176 liter per second for intake flow and 24.544 liter per second for exhaust flow at 88.9cm H2O test pressure and 32.096 liter per second for intake flow and 19.824 liter per second for exhaust flow at 63.5cm H2O test pressure. The experiment results shown that, increasing the valve lift and test pressure can be increasing the correction test flow or air flow in intake manifold or air flow in exhaust manifold, but after the maximum valve lift, the correction test flow is stabile and can't increasing.

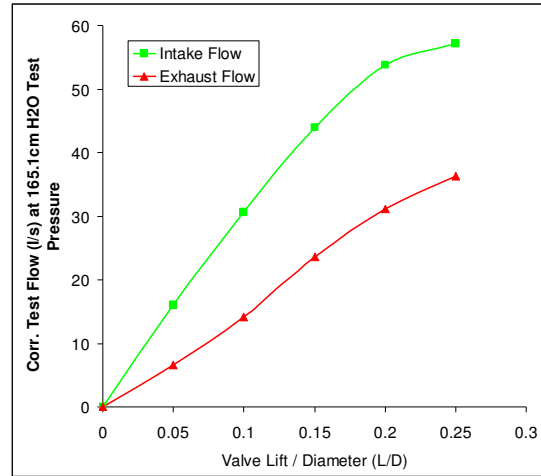

Fig. 4: Correction test flow at 165.1cm H2O pressure

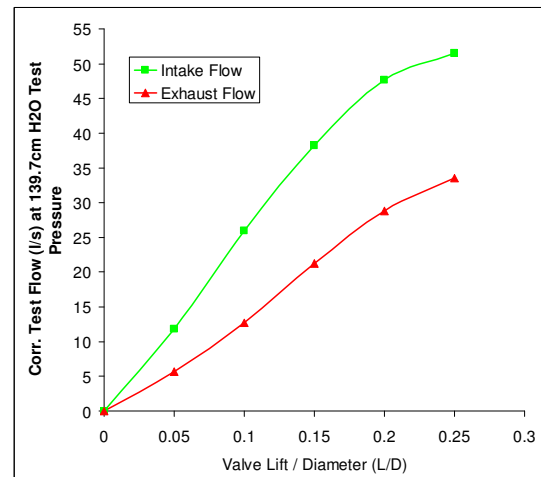

Fig. 5: Correction test flow at 139.7cm H2O pressure

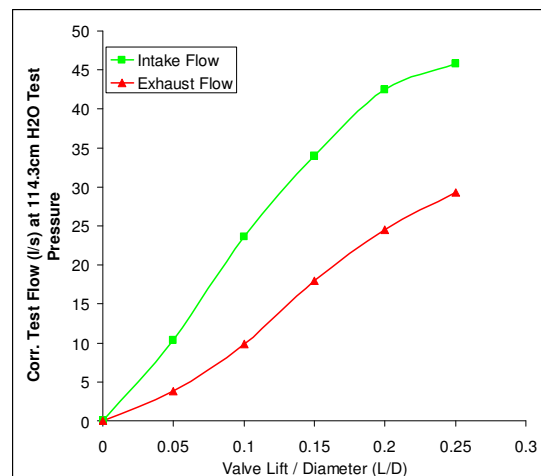

Fig. 6: Correction test flow at 114.3cm H2O pressure

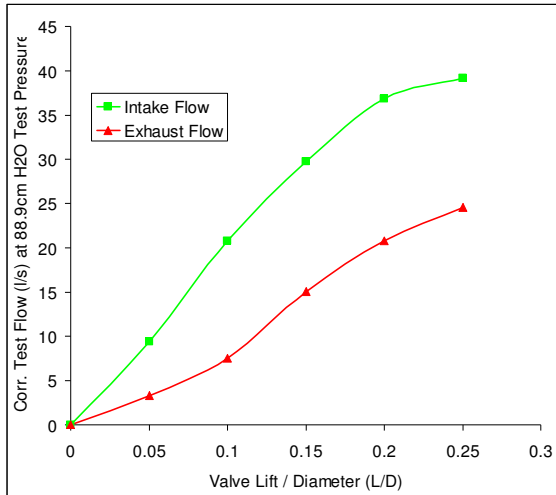

Fig. 7: Correction test flow at 88.9cm H2O pressure

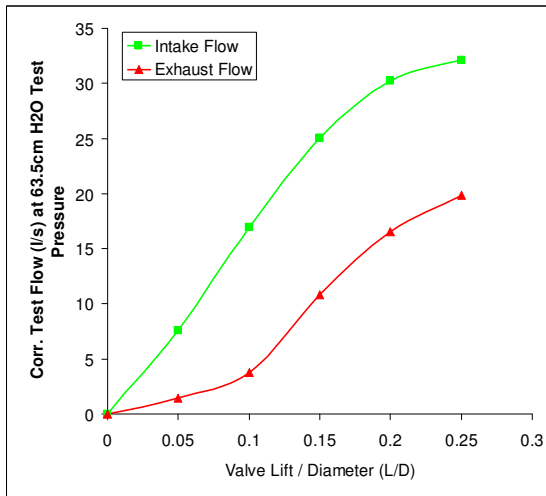

Fig. 8: Correction test flow at 63.5cm H2O pressure

Test flow or valve air flow of the superflow flowbench is the air flow from intake valve to engine cylinder or air flow from engine cylinder to exhaust valve divide by the effective valve area. The test flow from this experiment result is based on difference pressure and difference valve lift per diameter (L/D). The experiment results are shown in Fig. 9 – Fig. 13.

Fig. 9 shows the test flow of in valve air flow in potential flow, intake flow and exhaust flow at 165.1cm or 65in H2O test pressure, Fig. 10 shows the test flow of in valve air flow in potential flow, intake flow and exhaust flow at 139.7cm or 55in H2O test pressure, Fig. 11 shows the test flow of in valve air flow in potential flow, intake flow and exhaust flow at 114.3cm or 45in H2O test pressure, Fig. 12 shows the test flow of in valve air flow in potential flow, intake flow and exhaust

flow at 88.9cm or 35in H2O test pressure and Fig. 13 shows the test flow of in valve air flow in potential flow, intake flow and exhaust flow at 63.5cm or 25in H2O test pressure. In this experiment results shown that increasing the valve lift from 0L/D until 0.25L/D or 0mm until 8.89mm for intake valve lift and 0mm until 7.26mm for exhaust valve lift can be increasing the valve air flow or test flow in the potential flow, intake flow and exhaust flow. Fig. 9 – Fig. 13 shows that, the test flow trend for potential flow, intake flow and exhaust flow from 0L/D until 0.25L/D is increase and after 0.25L/D is stabile or horizontal. It is shown that the maximum test flow or valve air flow of the diesel engine is near after the maximum intake valve lift or maximum exhaust valve lift at 7.094mm.

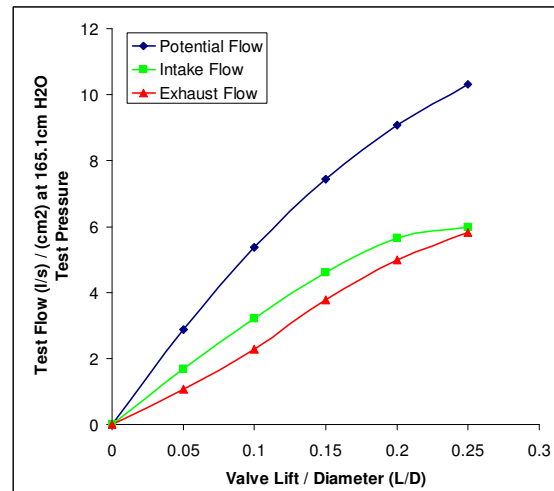

Fig. 9: Test flow at 165.1cm H2O pressure

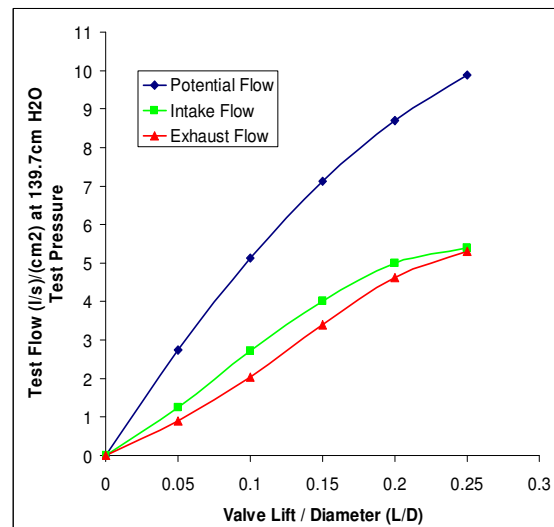

Fig.10: Test flow at 139.7cm H2O pressure

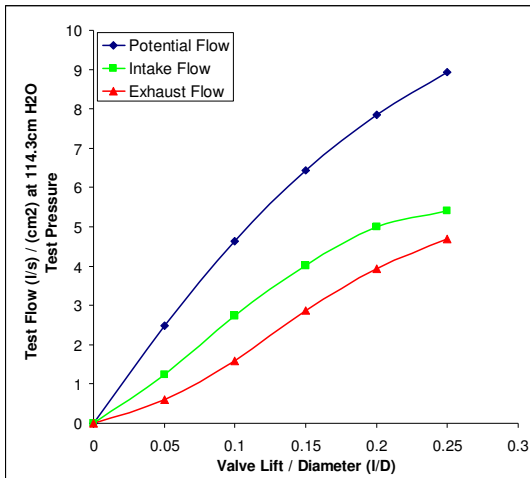

Fig. 11: Test flow at 114.3cm H2O pressure

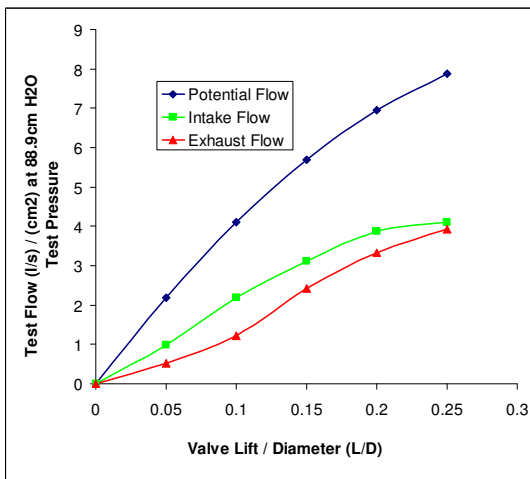

Fig. 12: Test flow at 88.9cm H2O pressure

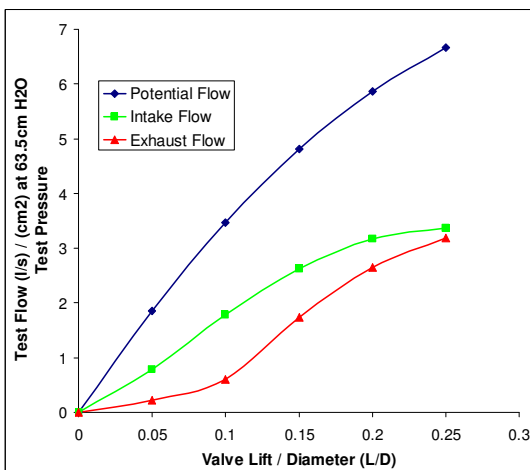

Fig. 13: Test flow at 165.1cm H2O pressure

The nominal maximum valve air flow is shown in Fig. 9 – Fig. 13. Fig. 9 shows the nominal maximum flow is 10.32 (l/s)/(cm²) for potential flow, 5.992 (l/s)/(cm²) for intake flow and 5.829 (l/s)/(cm²) for exhaust flow at 165.1cm H2O test pressure. Fig. 10 shows the nominal maximum flow is 9.873 (l/s)/(cm²) for potential flow, 5.398 (l/s)/(cm²) for intake flow and 5.299 (l/s)/(cm²) for exhaust flow at 139.7cm H2O test pressure. Fig. 11 shows the nominal maximum flow is 8.926 (l/s)/(cm²) for potential flow, 5.398 (l/s)/(cm²) for intake flow and 4.693 (l/s)/(cm²) for exhaust flow at 114.3cm H2O test pressure. Fig. 12 shows the nominal maximum flow is 7.878 (l/s)/(cm²) for potential flow, 4.111 (l/s)/(cm²) for intake flow and 3.936 (l/s)/(cm²) for exhaust flow at 88.9cm H2O test pressure. Fig. 13 shows the nominal maximum flow is 6.665 (l/s)/(cm²) for potential flow, 3.368 (l/s)/(cm²) for intake flow and 3.179 (l/s)/(cm²) for exhaust flow at 63.5cm H2O test pressure. The experiment results shown that, increasing the valve lift and test pressure can be increasing the valve air flow or test flow in potential flow, intake valve air flow and exhaust valve air flow, but after the maximum valve lift the intake valve air flow and the exhaust valve air flow is stabile.

The coefficient of discharge (CD) of the superflow flowbench test flow from this experiment result is shown in Fig. 14 – Fig. 18. The CD investigation is based on difference pressure and valve lift per diameter. Coefficient of discharge in this experiment results shown that, increasing the pressure and valve lift from 0L/D until 0.25L/D or 0mm until 8.89mm for intake valve lift and 0mm until 7.26 for exhaust valve lift can be increasing the coefficient of discharge in the intake CD and exhaust CD.

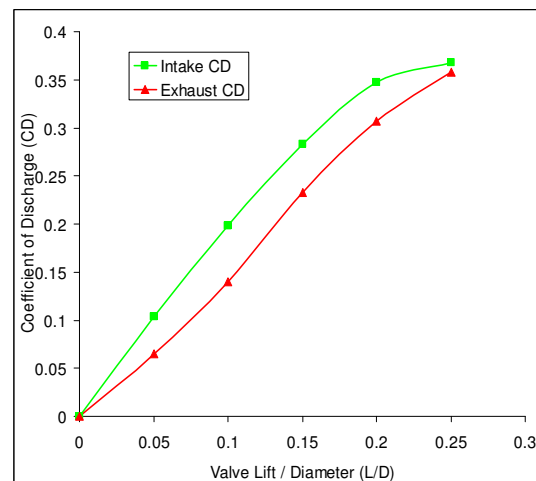

Fig. 14: CD at 165.1cm H2O test pressure

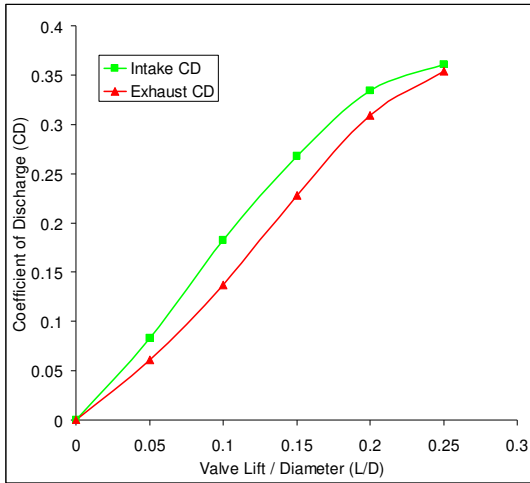

Fig. 15: CD at 137.9cm H2O test pressure

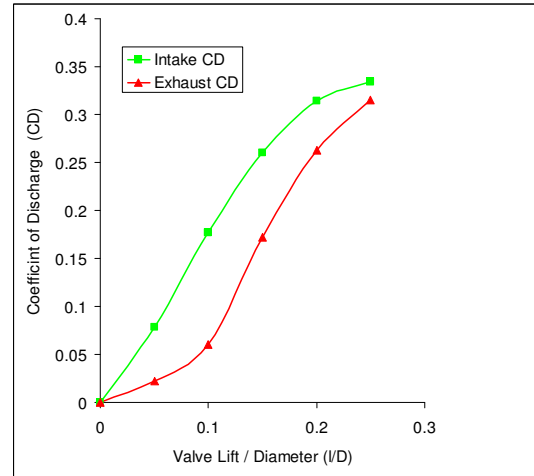

Fig. 18: CD at 63.5cm H2O test pressure

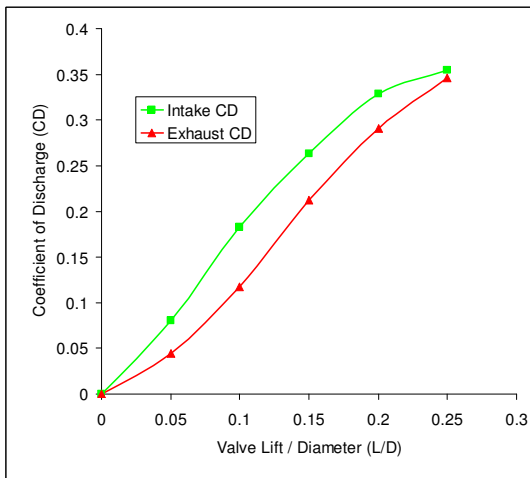

Fig. 16: CD at 114.3cm H2O test pressure

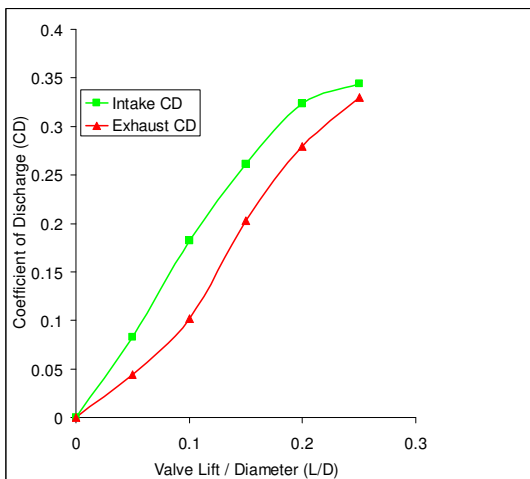

Fig. 17: CD at 88.9cm H2O test pressure

Fig. 14 – Fig. 18 shows that, the coefficient of discharge for intake and exhaust trend from 0L/D until 0.25L/D is increase and after 0.25L/D is stable or horizontal. Fig. 14 shows the nominal maximum coefficient of discharge is 0.368 for intake flow and 0.358 for exhaust flow at 165.1cm H2O test pressure. Fig. 15 shows the nominal maximum coefficient of discharge is 0.361 for intake flow and 0.354 for exhaust flow at 139.7cm H2O test pressure. Fig. 16 shows the nominal maximum coefficient of discharge is 0.355 for intake flow and 0.34674 for exhaust flow at 114.3cm H2O test pressure. Fig. 17 shows the nominal maximum coefficient of discharge is 0.344 for intake flow and 0.329 for exhaust flow at 88.9cm H2O test pressure. Fig. 18 shows the nominal maximum coefficient of discharge is 0.334 for intake flow and 0.315 for exhaust flow at 63.5cm H2O test pressure. The experiment results shown that, increasing the valve lift and test pressure can be increase the coefficient of discharge in intake manifold or in exhaust manifold, but after the maximum valve lift, the coefficient of discharge is stable and can't increasing.

CONCLUSION

All of the valve lift examined in various test pressures in this experiment. The experiment results shown that, the air flow, valve air flow and coefficient of discharge in the intake port and exhaust port of the four stroke diesel engine provided the best in the maximum valve lift per diameter 0.25L/D and in highest test pressure. The experiment results shown that, increasing the valve lift and test pressure can be increasing the air flow, valve air flow and coefficient of discharge in intake manifold system or in exhaust

manifold system, but after the maximum valve lift per diameter 0.25L/D, the air flow, valve air flow and coefficient of discharge is stable and can't increasing.

ACKNOWLEDGEMENTS

We would like to express our great acknowledge to University Malaysia Pahang for providing the funding GRS070121 & GRS070122 and the facilities to support this research project.

REFERENCES

1. Heywood, J.B., 1998. Internal Combustion Engine Fundamentals. McGraw-Hill, Singapore.
2. Bakar, Rosli.A., Semin., Ismail, Abdul.R., 2007. The internal combustion engine diversification technology and fuel research for the future: A Review, Proceeding of AESEAP Regional Symposium on Engineering Education, Kuala Lumpur, Malaysia, pp: 57-62.
3. Kowalewicz, Andrzej., 1984. Combustion System of High-Speed Piston I.C. Engines, Wydawnictwa Komunikacji i Łączności, Warszawa.
4. Stone. Richard., 1997. Introduction to Internal Combustion Engines-2nd Edition, SAE Inc.
5. Ganesan, V., 1999. Internal Combustion Engines 2nd Edition, Tata McGraw-Hill, New Delhi.
6. Bakar, Rosli.A., Semin., Ismail, Abdul.R., 2007. Effect Of Engine Performance For Four-Stroke Diesel Engine Using Simulation, Proceeding of The 5th International Conference On Numerical Analysis in Engineering, Padang, Indonesia.
7. Fleck, Robert., Cartwright, Anthony., 1996. Coefficients of discharge in high performance two-stroke engines, SAE Technical Paper 962534.
8. SuperFlow Technologies Group, 2004. SF-1020 Flowbench Operators' Manual, SuperFlow Corporation, Colorado Springs, USA.
9. Blair, G. P., Lau H. B. , Cartwright, A., Raghunathan, B. D., Mackey, D. O., 1995. Coefficients of discharge at the apertures of engines, SAE Technical Paper 952138.
10. Blair, G. P., McBurney, D., McDonald, P., McKernan, P., Fleck, R., 1998. Some fundamental aspects of the discharge coefficients of cylinder porting and ducting restrictions, SAE Technical Paper 980764.
11. Danov, S., 1997. Identification of discharge coefficients for flow through valves and ports of internal combustion engines, SAE Technical Paper 970642.